

Quick Installation Guide  
AC Charger  
AC22E-01



- The contents of the document will be periodically updated or revised due to the product development. It is probably that there are changes of document in the subsequent edition. Under no circumstances can this document replace the user manual and the safety instructions on the product.
- Please read the user manual and relevant standards and specifications carefully before performing any operation. You can get the information by logging in Sungrow support platform via <http://support.sungrow-power.com/> or scanning the QR code on the side of the product or on the back cover of the quick installation instruction.
- All operations shall only be performed by qualified personnel. Qualified personnel must be trained specially, read this instruction thoroughly, master the safety instructions related to operation and be familiar with the local standards and safety regulations of electrical system.
- Before installing the equipment, check whether the goods are complete and consistent with the order, and whether there is obvious damage according to the packing List. Contact the shipping company or SUNGROW directly in case of any damage or incompleteness.
- Cables used for the charger must be intact and well-insulated. Use insulation tools and wear personal protective equipment.
- Violation of any of the above requirements may cause casualties or equipment damage.

## Safety Statement

Failure to comply with the requirements of this document and the user manual may cause casualties or equipment damage, and SUNGROW shall not assume any liability.

### DANGER

In the TT, TN-C and TN-S system, make sure that the ground cable is connected reliably. Otherwise, it may cause electric shock.

### DANGER

- High voltages are present during operation and could cause electrical shock, resulting in death, serious personal injury, or property damage.
- Non-professional personnel shall not disassemble the components.

### CAUTION

Keep the charger away from flammable and explosive substances. Store it in a dry, clean, and well-ventilated place, free from harmful gases. Do not store it near the corrosive objects.











### NOTICE

- During transport, the charger shall be securely packed in a wooden box, and marked with the loading direction. The charger shall not be stored upside down.
- During transport, tighten the equipment to avoid violent shaking and bumps that damage the package.
- After the arrival of goods, check for transport damage and, if any, contact the shipping company or us.
- Check if the devices inside the package are the same as that of the delivery list.

### NOTICE

Type A residual-current device should be installed in the front stage of the charger. (Parameter: 40 A/400 V with a rated residual current of 30 mA)

The symbols on the charger body are as follows.

 Disconnect the inverter from all the external power sources before service!	 There is a danger from a hot surface that may exceed 60°C.
 Read the user manual before maintenance!	 Do not dispose of the inverter together with household waste.
 TUV mark of conformity.	 UKCA mark of conformity.
 CE mark of conformity. EU/EEA Importer	  Danger to life due to high voltages! Do not touch live parts for 10 minutes after disconnection from the power sources. Only qualified personnel can open and maintain the inverter.
 RoHS labeling. The product complies with the requirements of the applicable EU directives.	

# EU Declaration of Conformity



within the scope of the EU directives:

- Low Voltage Directive 2014/35/EU (LVD)
- Electromagnetic compatibility Directive 2014/30/EU (EMC)
- Radio Equipment Directive 2014/53/EU (RED)
- The restriction of the use of certain hazardous substances (RoHS) in electrical and electronic equipment Directive 2011/65/EU and Commission Delegated Directive (EU)2015/863

SUNGROW confirms herewith that the products described in this document are in compliance with the fundamental requirements and other relevant provisions of the above-mentioned directives. The entire EU Declaration of Conformity can be found at [support.sungrowpower.com](http://support.sungrowpower.com).

## Radio data

Radio Technology	WIFI
------------------	------

Radio frequency band(s)	802.11b/g/n 2412~2472MHz
Maximum transmitted power	19.5 dBm

Function	RFID
----------	------

Operating band/frequency	13.56MHz
Maximum radiated H-field	10 dB $\mu$ A/m

Function	LTE
----------	-----

Operating band/frequency	LTE band 1	1920~1980 MHz
	LTE band 3	1710~1785 MHz
	LTE band 7	2500~2570 MHz
	LTE band 8	880~915 MHz
	LTE band 20	832~862 MHz
	LTE band 28	703~736 MHz
	LTE band 38	2570~2620 MHz
	LTE band 40	2300~2400 MHz
	Maximum transmitted power	LTE band 1
LTE band 3		25.0dBm
LTE band 7		25.0dBm
LTE band 8		25.0dBm
LTE band 20		25.0dBm
LTE band 28		25.0dBm
LTE band 38		25.0dBm
LTE band 40		25.0dBm

\*Technical parameters listed above apply to EU countries only.

# Packing List



AC Charger



Backplate



Socket



Expansion screw x 9



Hexalobular socket pan head tamper proof screws x 2



OT Terminals x 5



Cable fastener



L-shaped wrench (T10)



LAN connector set x 1



RJ45 protection sleeve x 2



RFID card x 2

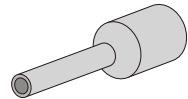

Euro terminals x 2

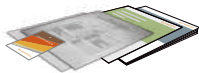

Documents

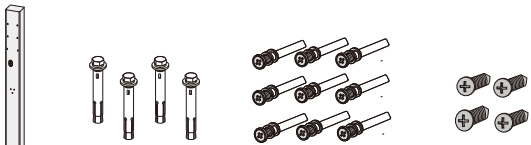

Mounting pole (optional)

## Mounting Place

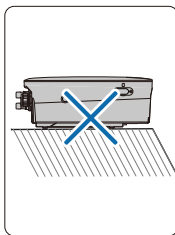
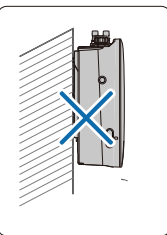
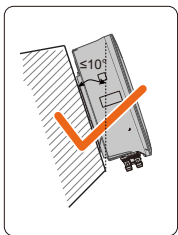
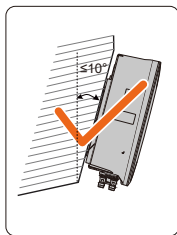
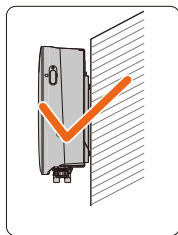
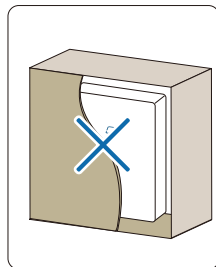
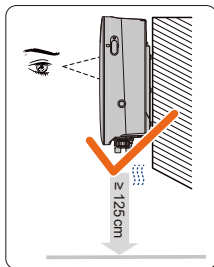
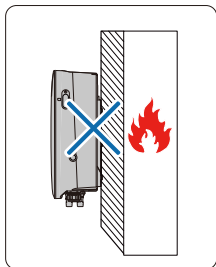
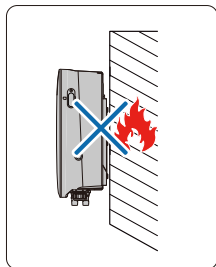
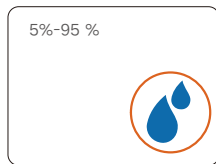
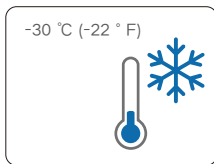
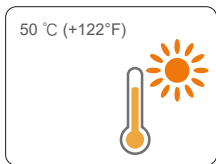

Location	Distance(mm)
Top	≥350
Bottom	1250
Left	≥100
Right	≥300

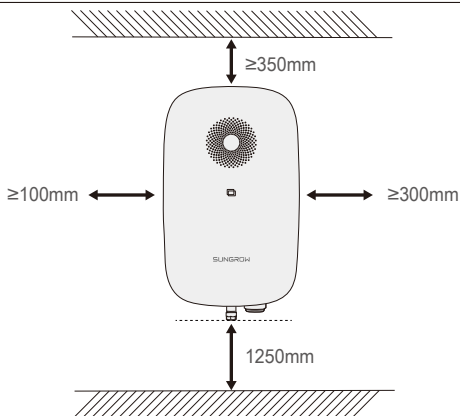

## Installation Tools

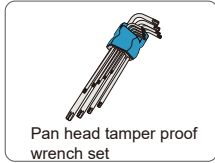
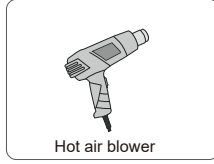
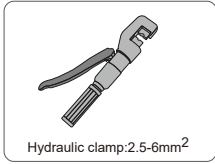
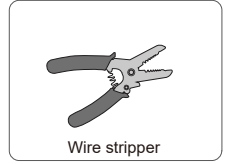
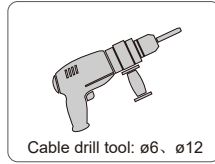
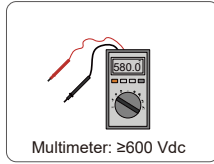
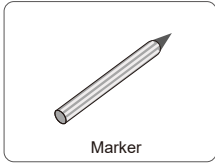

## Dimensions and Weight

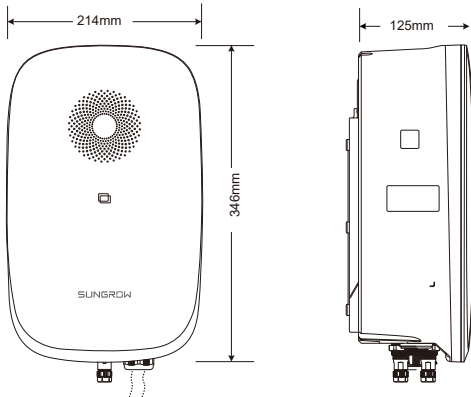

Name	Weight
AC22E-01	$\leq 7$ kg (with plugs)

# Wall-mounted Charger Installation

## Backplate and Socket Installation

 Before drilling, avoid water pipes and electricity wires in the wall to prevent hazards. The drill size is  $\Phi 6\text{mm}$  and the drilling depth is about **45mm**. The bearing capacity of the installation carrier shall be at least **4.5 times** that of the charger!

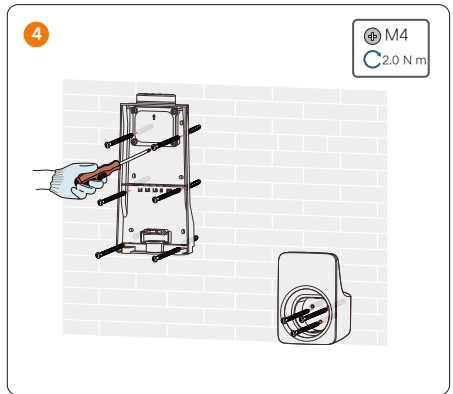
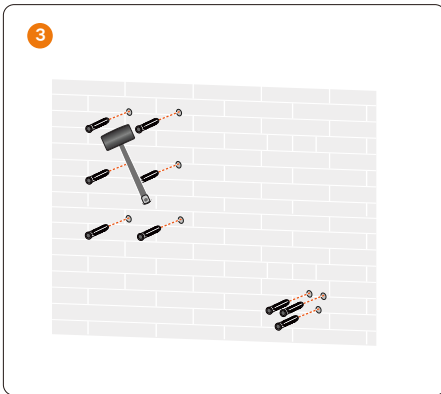
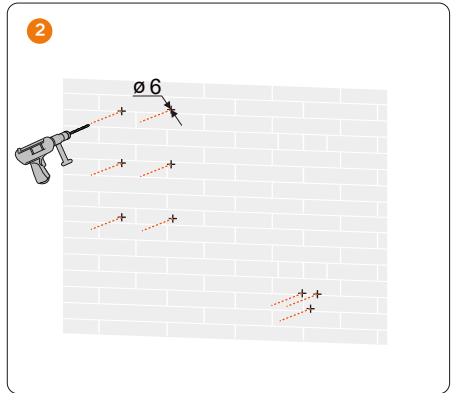
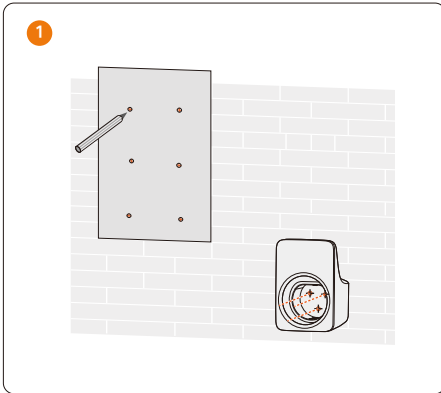

## AC Cable Connection

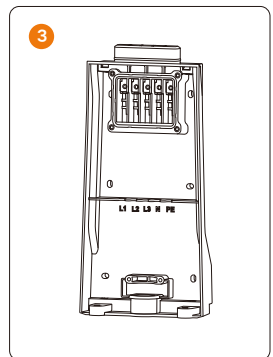
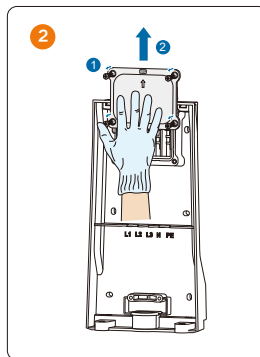
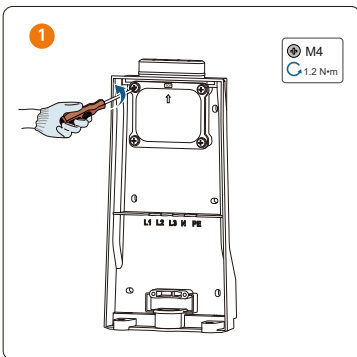

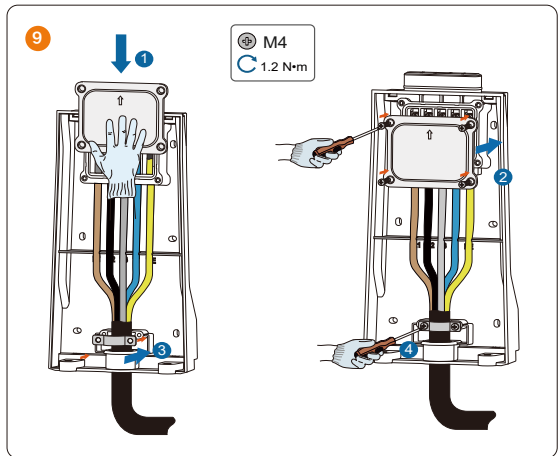
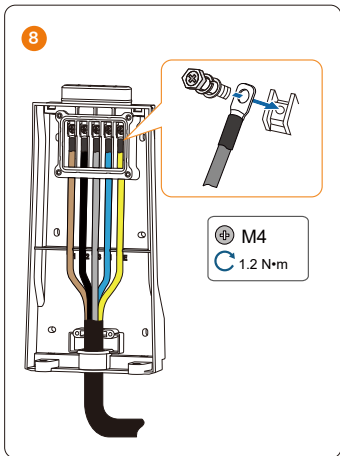
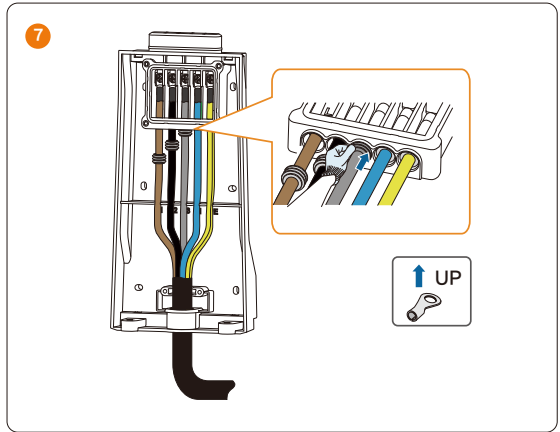
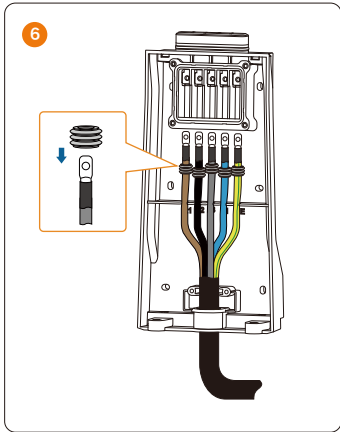
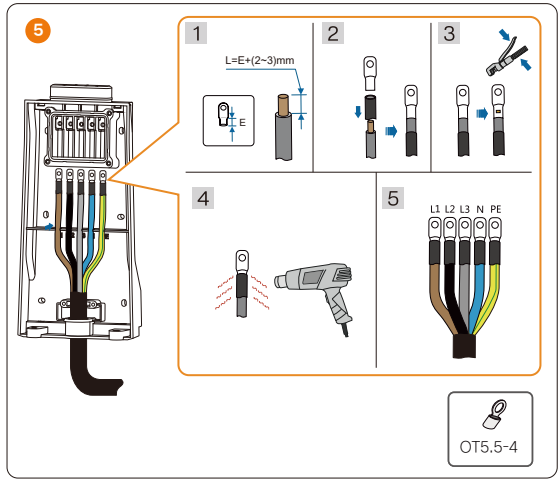
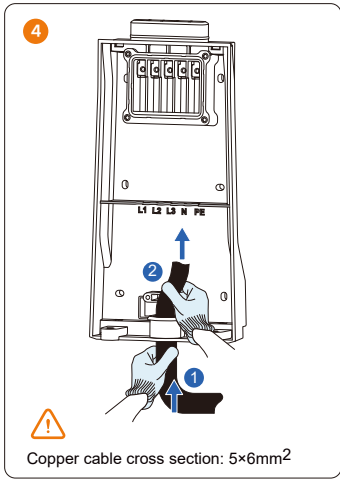

## Charger Installation

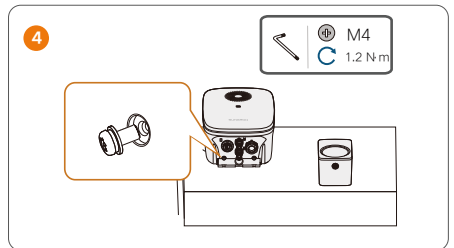
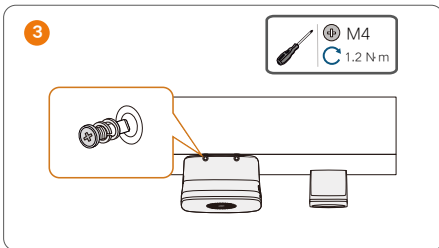
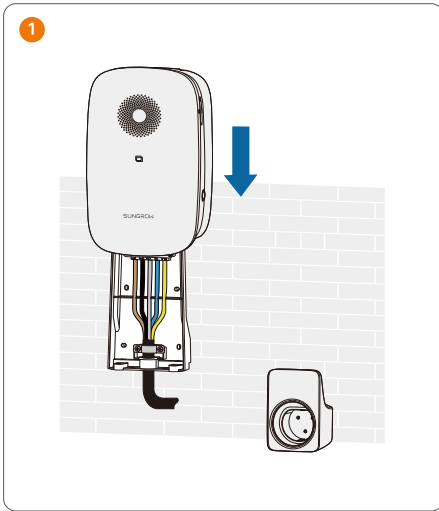

## SIM Card Installation

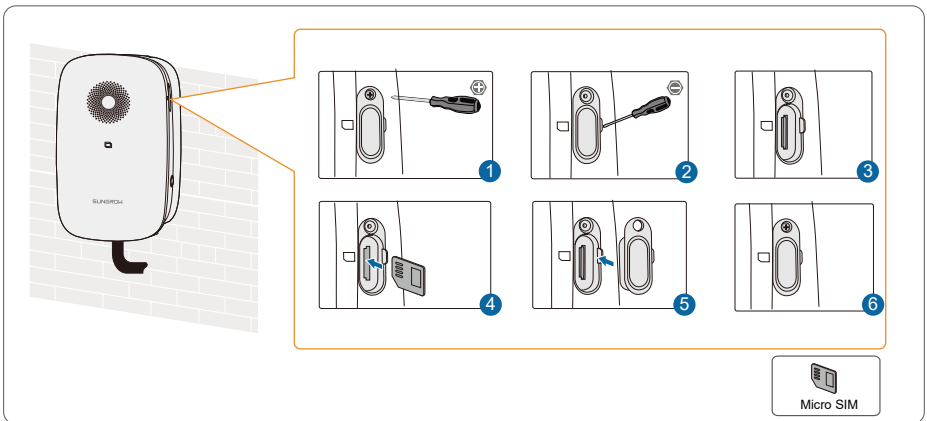

# Pole-mounted Charger Installation

## Pole Installation

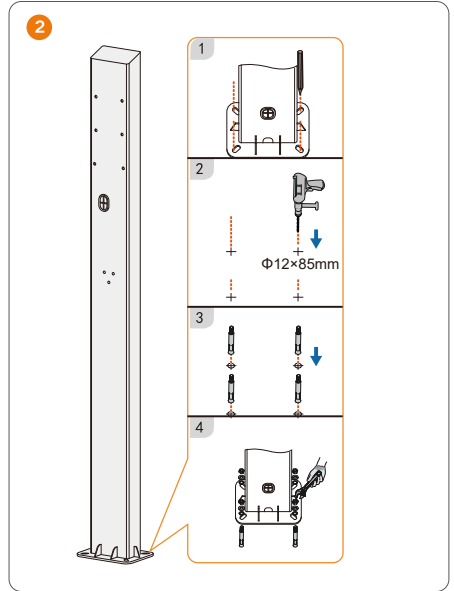
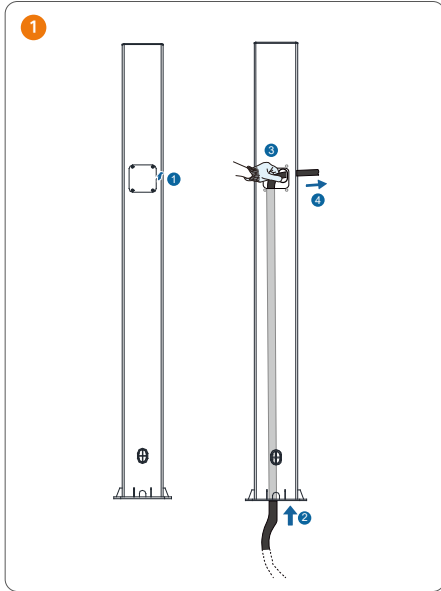

## AC Charger Installation

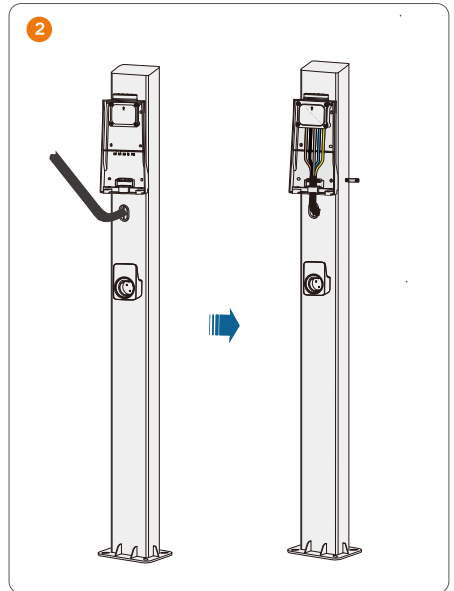
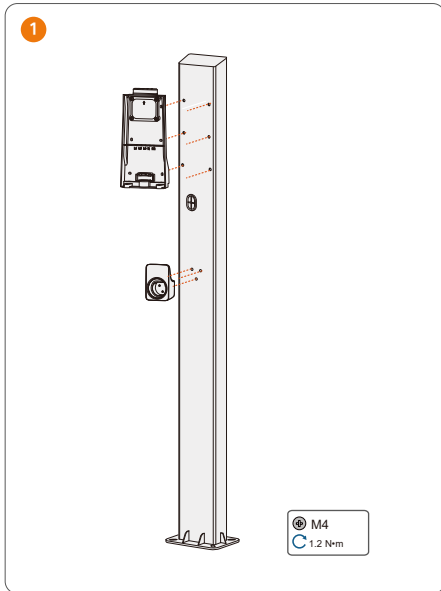

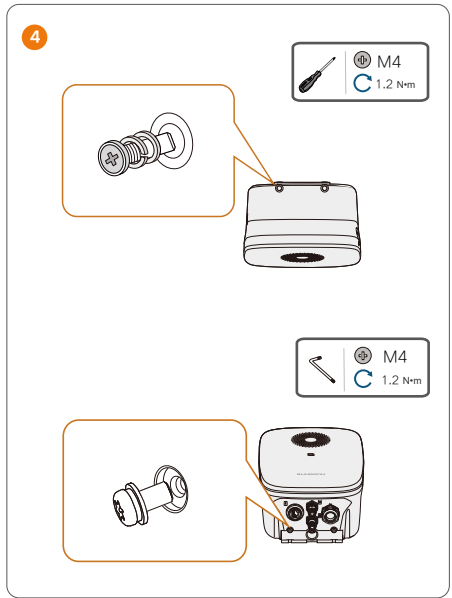
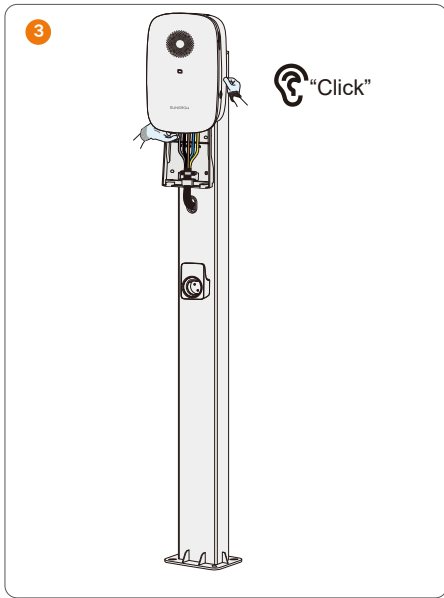

### SIM Card Installation

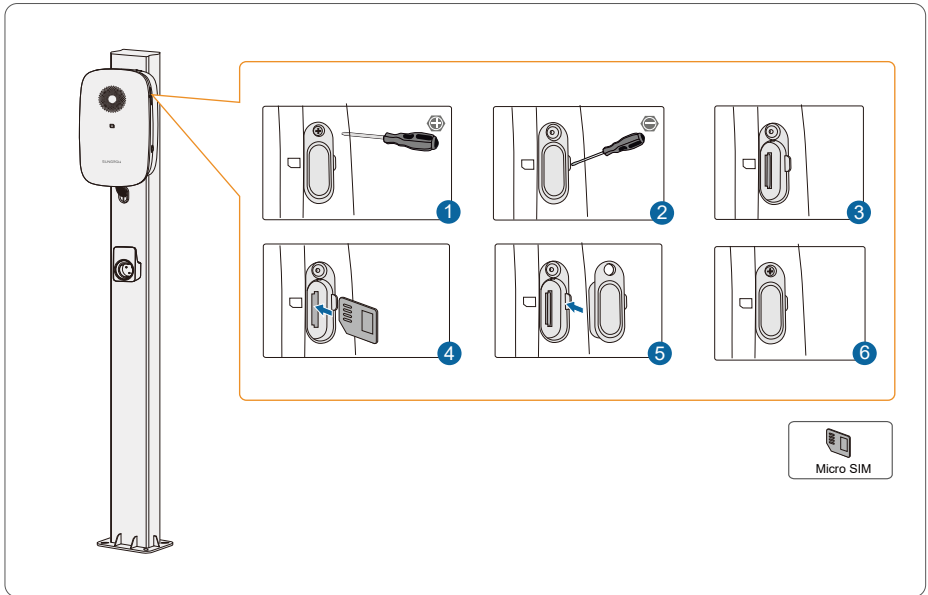

## External Interface

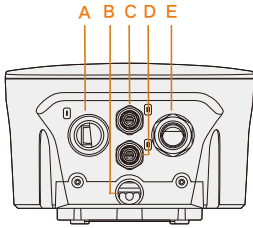

No.	Explanation
A	Network communication
B	AC input from the utility grid
C	RS485 Port 1 for connection to the Hybrid Inverter
D	RS485 Port 2 for connection to the Smart Energy Meter
E	Charging cable output (preinstalled)

## Network Communication Connection

1

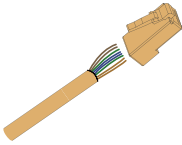

Plastic interface from the bottom  
 A: 6.604mm (REF)  
 Shrapnel interface from the bottom  
 B: 6.0198±0.127mm  
 ΔAB: 0.46~0.71mm

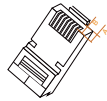

2

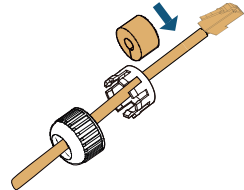

3

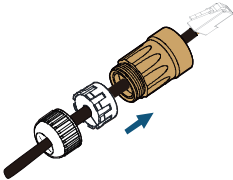

4

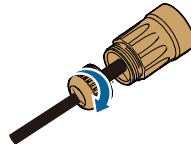

5



1

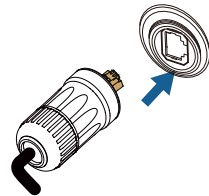

2



# RS485 Connection

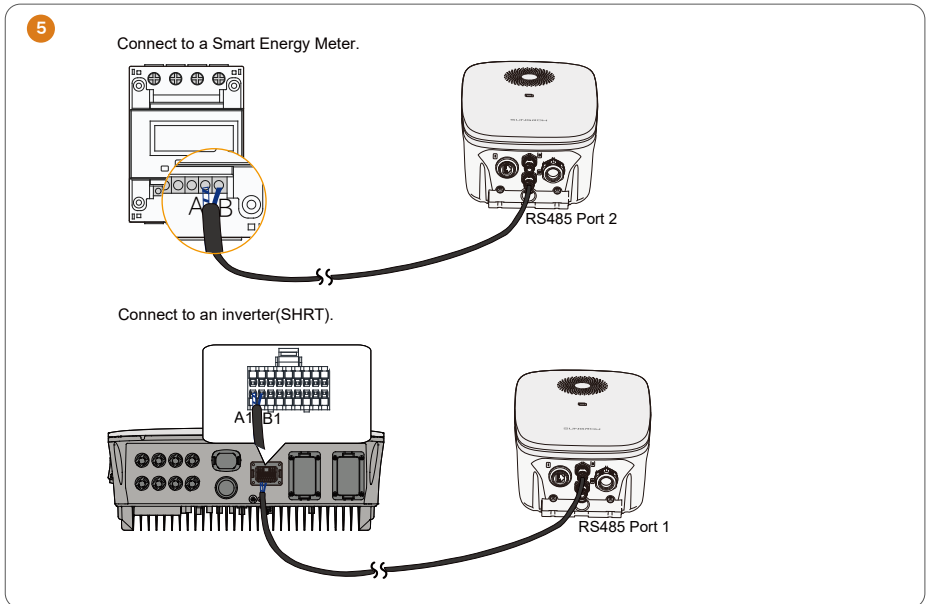
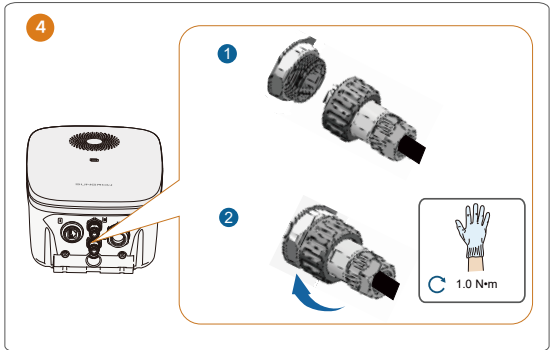
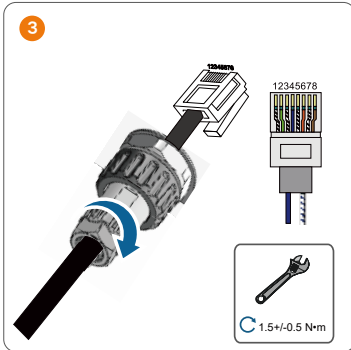
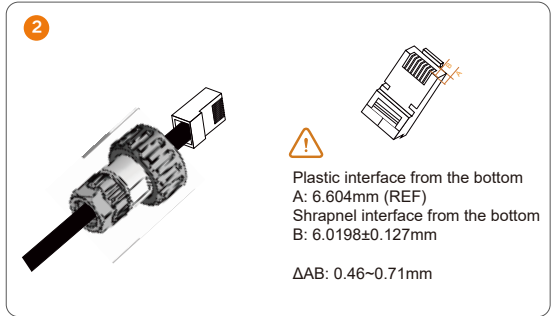
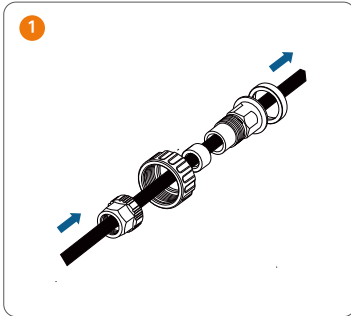

## Inspection Before Commissioning

No.	Item	Checklist	
		Yes	No
1	Install an individual residual current protection device to the utility grid.	<input type="checkbox"/>	<input type="checkbox"/>
2	The installation place is convenient for operation and maintenance.	<input type="checkbox"/>	<input type="checkbox"/>
3	The charger is installed securely.	<input type="checkbox"/>	<input type="checkbox"/>
4	With sufficient cooling space.	<input type="checkbox"/>	<input type="checkbox"/>
5	Cable is connected correctly and firmly.	<input type="checkbox"/>	<input type="checkbox"/>
6	Cables are routed safely and protected against mechanical damage.	<input type="checkbox"/>	<input type="checkbox"/>

## Commissioning

Step 1 Confirm that all requirements are met before commissioning;

Step 2 Turn on the cable inlet leakage protection circuit breaker;

Step 3 Power on the charger. It takes 1 minute for the charger to set up.

Step 4 The blue indicator is steady on which indicates the charger is in standby mode.

Step 5 Download the iEnergyCharge app, and follow the on-screen instructions to configure the network.

 Please connect the charger to the network in one of the following three ways:

- The ethernet cable is plugged in the RJ45 socket "LAN". Please refer to "Ethernet Communication Connection" for details.
- Or the SIM card is inserted. Please refer to "SIM Card Installation" for details. (The SIM card should be inserted before powered up).
- Or a strong and stable Wi-Fi connection is present at the charger location.

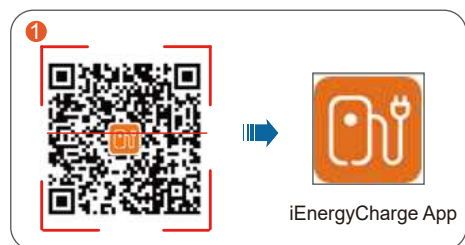

3 Skip this step if an Ethernet cable or a SIM card is used for network connection.

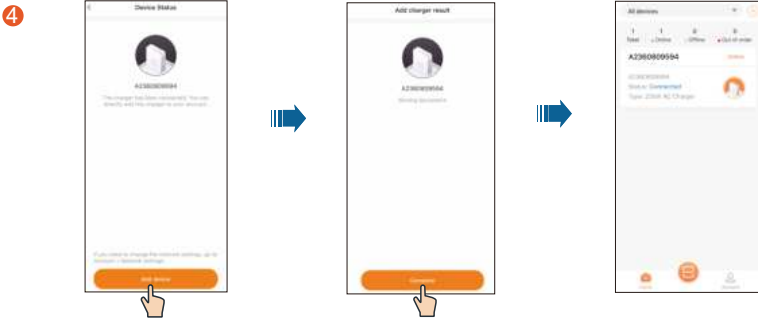
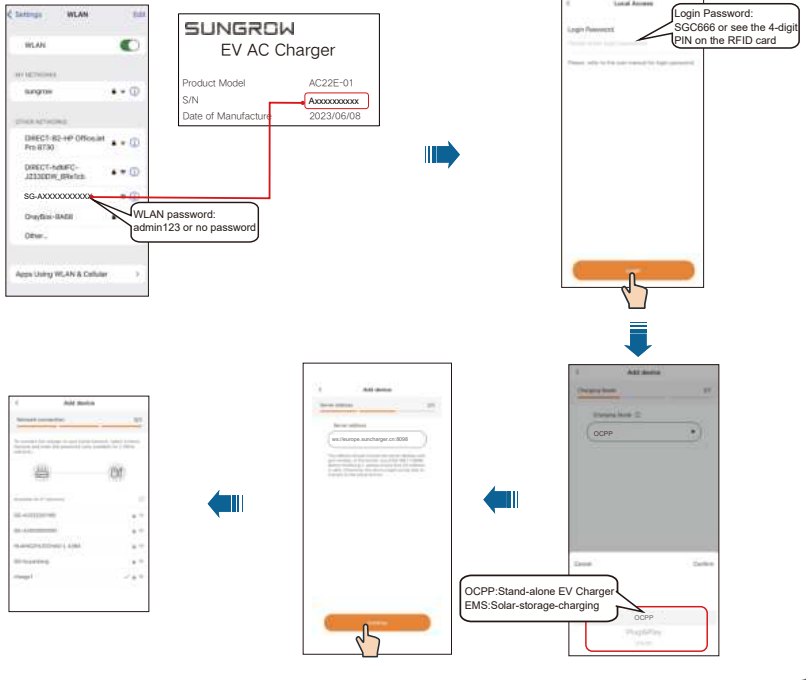

## The Status Description of LED Indicators

Charger status	Indicator
Charger standby or charging is complete while charging connector remain plugged-in	The blue indicator is steady on
The charger connector is connected to the vehicle	The blue indicator flashes, on for 0.5s and off for 0.5s
Vehicle charging	The blue indicator breathes
Faults occurs(check the fault type through App)	The red indicator is steady on
RFID charger card used	The blue indicator flashes for 5 times, on for 0.2s and off for 0.2s



More information in the QR code or  
at <http://support.sungrowpower.com/>